

## SYNTHESIS AND CHARACTERIZATION OF HARDENED Cu-Fe-Ni-P ALLOY

Received – Prispjelo: 2014-02-21

Accepted – Prihvaćeno: 2014-07-15

Original Scientific Paper – Izvorni znanstveni rad

In the manufacturing industry of electrical contacts, the prohibition of the use of toxic metals (Cd, Be), and desire to avoid the alloying with precious metals (Ag) has created a need for new alloys with good electrical conductivity and high mechanical properties at elevated temperatures. As a potentially useful material for this purpose, we have analyzed the continuously cast Cu-Fe-Ni-P alloy in various heat treatment conditions. Sequence of phase transformations during heat treatment was followed by 4 point D.C. electrical resistivity measuring method, and analyzed by scanning (SEM) and transmission (TEM) electron microscopy. Measurements of Vickers hardness and electrical conductivity after various heat treatment procedures indicate on high potential of Cu-Fe-Ni-P alloys as a material for electrical contacts.

*Key words:* copper alloys, precipitation hardening, electrical contacts, electrical conductivity

### INTRODUCTION

The increasing mechanical and electrical property requirements and inexpensiveness of contact materials remain the main challenge for the producers of copper and copper alloys for the automotive and electro industry. The electrical conductivity of pure copper (100 % I.A.C.S) is in the majority of practical cases useless, if the mechanical and metallurgical properties don't meet required demands. Especially resistance to erosion by arcing and undesired welding of contacts, recrystallization temperature, mechanical and chemical stability at elevated temperatures are sometimes more important than the electrical conductivity by itself. Selecting the proper electrical contact material is always a compromise between electrical and other properties required by a certain application.

In the present industrial practice a number of copper alloys are used as contact materials. Their selection depends mostly by the type of electrical contact and the magnitude of current and voltage they have to conduct or break. Most of copper based alloys for high current/medium or low voltage make-break contacts contain precious metals (Ag alloyed or Ag plated, Cu-Te) or toxic metals (Cd, Be) [1, 2]. Desire for replacement is therefore obvious.

Hardening of pure copper can be achieved by cold working, solute hardening, and precipitation or dispersion hardening. Pure copper is, in general, unsuitable for contact tips due to its tendency to welding at high

currents and medium or low voltages [3]. Because solute hardening has a detrimental influence on electrical conductivity, there is no other alternative as precipitation or dispersion hardening. For both, not only chemical composition, but also proper heat treatment has to be applied [4]. As a potentially useful and economically attractive material for electrical contacts, Cu-Fe-Ni-P alloy showed some promising properties [5,6].

### EXPERIMENTAL

The CuFe0,3Ni0,5P0,2 alloy with 0,3 mass. % Fe, 0,5 mass. % Ni and 0,2 mass.% P was made from industrially pure oxygen free copper, iron, nickel, and master alloy (Cu +8,8 mass. % P). Synthesis started with induction melting (4 kHz, 60 kW - Leybold furnace) followed by continuous casting by vertical continuous casting apparatus (Technical Gauss) with the graphite mould. Melting and continuous casting of rods was carried out in a vacuum (0,5 mbar) protective atmosphere. The casting parameters are given in Table 1.

By continuous casting we achieved better longitudinal homogeneity of castings, but due to the solidification mechanism in the continuous casting process, non-homogeneity through the perpendicular cross-section of

Table 1 **Casting parameters**

Casting procedure	P1	P2	P3
Alloy /mass. %	Cu-Ni 0,5-Fe 0,3-P 0,2		
Melt temperature /°C	1 180		
Rod diameter /mm	16		
Pulling cycle /mm	3	5	10
Pause l/s	0,2	0,2	0,2
Average casting velocity /mm/min	290	380	480

G. Brovč, G. Dražič, B. Karpe, B. Kosec, M. Bizjak, University of Ljubljana, Faculty of Natural Sciences and Engineering, Ljubljana, Slovenia; I. Djordjević, University of Belgrade, School of Dental Medicine, Belgrade, Serbia; G. Lojen, University of Maribor, Faculty of Mechanical Engineering, Maribor, Slovenia

the rod still remain. To eliminate this non-homogeneity, the rods were solution annealed in a protective argon atmosphere at the temperature 930 °C for one hour and quenched in water.

The sequence of the microstructural changes in annealed and quenched samples during heating was followed by the in-situ measurements of the electrical resistance. For measurements of the electrical resistance during heating, the four-point D.C. method with the changeable polarity of the measuring current was applied. The disturbing effect of electromagnetic fields from the surrounding was successfully eliminated by the use of special measuring cables and electromagnetic shields [7,8]. All measurements were made at a constant heating rate of 5 K/min in the tube furnace with protective argon atmosphere. The temperature of the furnace was simultaneously measured by an S-type thermocouple [9]. Schematic diagram of the measuring system is shown in Figure 1.

After determination of the entire electrical resistance temperature dependency up to 800 °C, individual samples, taken from the same continuous cast rod, were heated in the argon protective atmosphere to the distinctive temperatures of electrical resistance deviations, and slowly cooled in the furnace. Microstructure transformations were analyzed by scanning (SEM) and transmission electron microscopy (TEM) [10]. Thin foils for TEM observation were prepared by grinding the sawed foils (200 µm) to approximately 40 µm, cutting out the 3 mm diameter disks and ion thinned with Gatan PIPS M,691 apparatus.

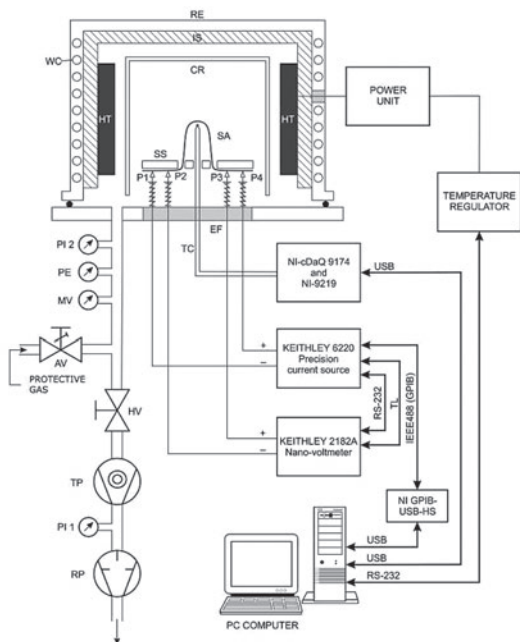

RE-Recipient, IS-Isolation, CR-Ceramic retort, WC-Water cooling, H-Heater, SA-Sample, SS-Sample support, P1, P2, P3, P4-Spring loaded measuring contacts, EF-Electric (cable) feed-trough, TC-Thermocouple, RP-Rotary pump, TP-Turbomolecular pump, HV-High vacuum valve, AV-Argon dosing valve, PI 1-Pirani vacuum gauge, PI 2-Pirani vacuum gauge, PE-Penning vacuum gauge, MV-Membrane vacuum gauge

**Figure 1** A scheme of a measuring system for in-situ electrical resistance measurement

## RESULTS AND DISCUSSION

Microstructure of a continuous cast rod in as cast state consists of columnar zone, with decreasing grain size and more directional orientation (parallel to the rod axis) in the center of the rod (Figures 2 and 3). Morphology of solidification is dendritic with alloying elements microsegregation in interdendritic spaces (Figure 4).

By solution annealing at 930 °C for 1 hour and quenching in water, a homogeneous supersaturated solid solution  $\alpha_{Cu}$  was obtained. The crystal grains didn't grow considerably due to relatively short annealing time (Figure 5).

The results of the electrical resistance measurements during heating with constant heating rate of 5 K/min are

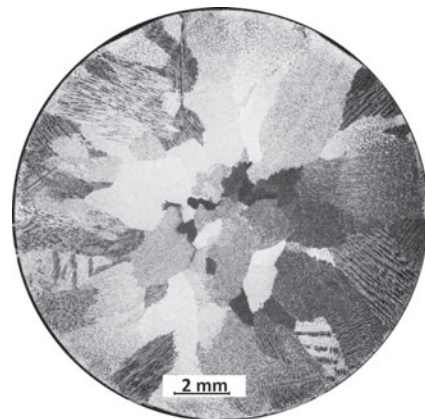

**Figure 2** Microstructure of a continuous cast rod in as cast condition. Perpendicular cross-section, P1 casting parameters

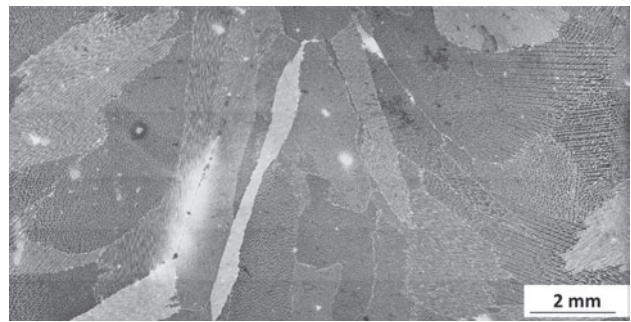

**Figure 3** Microstructure of a continuous cast rod in as cast condition. Longitudinal cross-section, P1 casting parameters

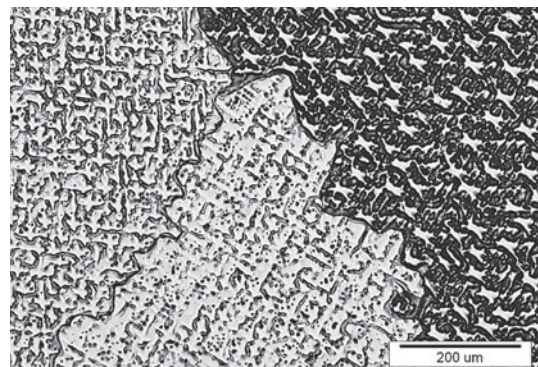

**Figure 4** Continuous cast CuFe<sub>0.3</sub>Ni<sub>0.5</sub>P<sub>0.2</sub> rod dendritic microstructure (as cast state, etched by ferri chloride)

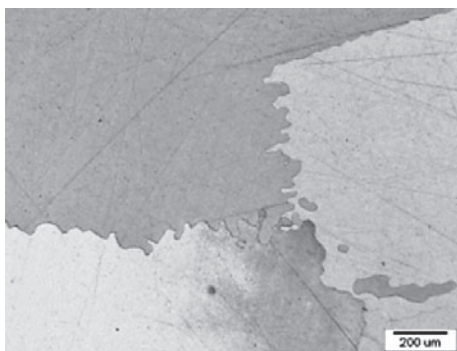

**Figure 5** The CuFe<sub>0,3</sub>Ni<sub>0,5</sub>P<sub>0,2</sub> alloy microstructure after annealing and quenching

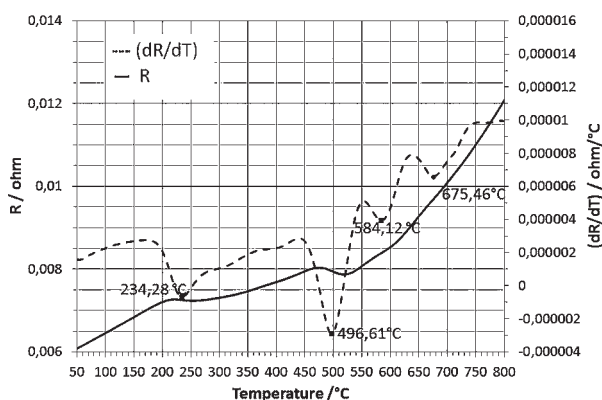

**Figure 6** Electrical resistance temperature dependency curve and its temperature derivative curve for CuFe<sub>0,3</sub>Ni<sub>0,5</sub>P<sub>0,2</sub> alloy

presented in Figure 6. At lower temperatures, up to approximately 200 °C, CuFe<sub>0,3</sub>Ni<sub>0,5</sub>P<sub>0,2</sub> alloy exhibits practically linear increase of electrical resistance with increasing temperature.

The main reason for this are increased thermal atom vibrations, which scatters electrons and consequently increases electrical resistivity of the alloy. At higher temperatures, the electrical resistivity temperature dependency becomes nonlinear, with several major deviations at distinctive temperature intervals. All measured curves exhibit two temperature intervals, where electrical resistance decreases with increasing temperature. First one, between 200 and 350 °C with the maximum rate of the electrical resistivity decrease at derivation minima  $T_{m1}$  at 234 °C and the second between 440 and 550 °C with the  $T_{m2}$  at 496 °C. There are also two temperature intervals with minor nonlinear changes in electrical resistance with the minima at 584 and 675 °C. The minima represent the temperature of the fastest response of electrical resistance on the microstructural changes in a certain temperature interval. This can be seen more precisely in the derivative curve  $\frac{dR}{dT}$  (see Figure 6). The exact values of the temperature intervals are heating rate dependant and shift towards higher temperatures with increasing heating rate, but the shape of the electrical resistance curve remains the same. From the measurements of electrical resistance (Table 2) we can see

**Table 2** The electrical resistance of CuFe<sub>0,3</sub>Ni<sub>0,5</sub>P<sub>0,2</sub> alloy samples after heating to distinctive temperatures

Annealing temperature / °C	Electrical resistance before heat treatment / mΩ	Electrical resistance after heat treatment / mΩ	$\Delta R$ / %	$\Delta R_1 - \Delta R_{n-1}$ / %
350	55,024	42,791	22,23	22,23
550	44,156	27,315	38,14	15,91
620	40,986	20,350	50,34	12,20
750	41,932	23,369	44,27	-6,07

that electrical resistance of the samples decreases with increasing temperature during heating up to the third temperature interval (620 °C). Decrease of electrical resistance is steeper at lower temperatures. In samples heated above the third temperature interval (750 °C) of the electrical resistance deviation, electrical resistance of the samples starts to increase again.

During heating over the first temperature interval of electrical resistance deviation (350 °C), supersaturated  $\alpha_{Cu}$  solid solution gradually decomposed by precipitation of fine 10 to 20 nm large particles. TEM electron microscopy revealed, that some of the particles are aggregates, composed of two different crystal phases (Figure 7).

It has been reported that iron and nickel form phosphides [8,9] such as: Fe<sub>2</sub>P, Ni<sub>2</sub>P [11], Fe<sub>3</sub>P [12], Ni<sub>5</sub>P<sub>2</sub>, Ni<sub>12</sub>P<sub>5</sub> [13] and ternary compound phosphides with manganese FeMnP [14] and NiMnP [15].

Major contribution to the electrical resistivity decrease during heating over the second temperature in-

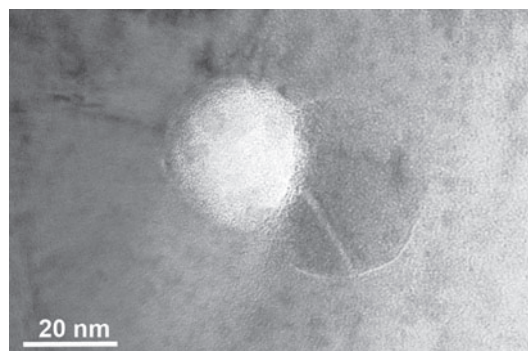

**Figure 7** TEM-micrograph of the twin type particle, precipitated from the  $\alpha_{Cu}$  supersaturated solid solution after heating up to 350 °C

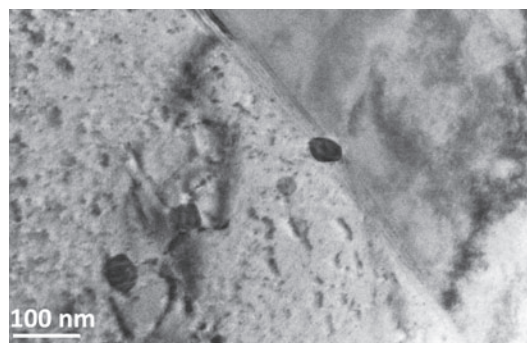

**Figure 8** The microstructure of the CuFe<sub>0,3</sub>Ni<sub>0,5</sub>P<sub>0,2</sub> alloy after heating up to 550 °C (TEM)

terval of electrical resistance deviation (550 °C) has a depletion of  $\alpha_{\text{Cu}}$  solid solution by precipitation of iron and nickel phosphides.

Aggregate type precipitates were still present in the same form and approximately of the same size (Figure 8), but the density of the particle distribution increased considerably.

In microstructure of the samples heated above the third distinctive temperature interval, up to 620 °C, the twin type particles were no longer detected. The process of continuous particle growth and coalescence took place during further heating up to 750 °C (Figure 9).

The connection between small electrical resistance increase (Table 2) in samples heated above  $T_{m4}$  could be explained by the EDS spot micro-analysis [16], which revealed transformation of phosphide particles with higher Ni/P ratio to a lower Ni/P ratio, which is in a good agreement with the authors [17, 18], who found  $\text{Fe}_2\text{P}$  and  $\text{Ni}_2\text{P}$  as stable phases after long periods of aging at 450 °C. It's well known that any kind of crystal lattice distortion, increases electrical resistivity of the metal. Solute atoms are particularly effective scattering centers for electrons and have the greatest effect on the electrical resistivity increase. The greatest influence on the electrical resistivity increase has P, followed by Si, Fe, Mn, Al, Ni, Sn, Zn.

Based on the electrical resistance measurements and metallographic researches, we set the temperature of precipitation annealing at 495 °C. Table 3 shows measured values of specimen electrical conductivities and hardnesses of the CuFe0,3Ni0,5P0,2 alloy after annealing at 495 °C for various holding periods.

Maximum electrical conductivity (73,71 % I.A.C.S. at 20 °C) as well as hardness (150 HV) was achieved after 3 hours of annealing at 495 °C. At longer periods of annealing, electrical conductivity starts to decrease.

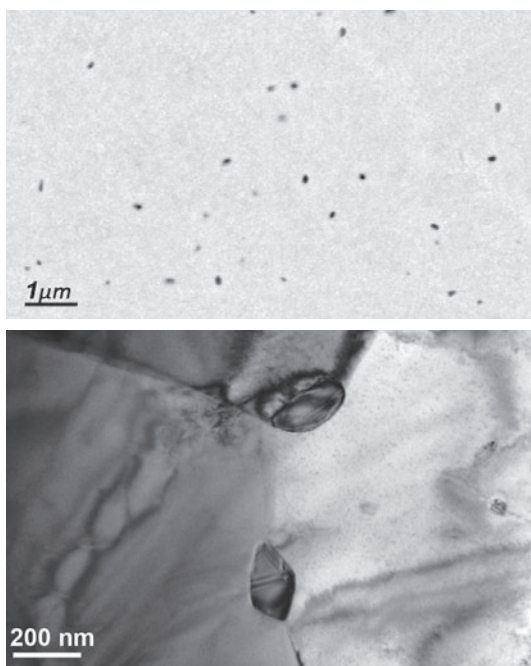

**Figure 9** Precipitates after heating over  $T_{m4}$  of electrical deviations: SEM (below) and TEM (above)

**Table 3** Electrical conductivity and hardness after annealing at 495 °C for various holding periods

Annealing time	$\gamma / \text{MSm}^{-1}$	$\Delta\gamma = \gamma_s - \gamma_g / \text{MSm}^{-1}$	I.A.C.S. /%	Hardness HV
Quenched	19,14	/	33,00	85
1 h	38,27	19,13	65,98	142
2 h	41,58	22,54	71,69	145
3 h	42,75	23,61	73,71	150
4 h	42,18	22,78	72,72	149

## CONCLUSIONS

From the microstructure of samples heated to distinctive temperatures of electrical resistance deviations can be seen, that decomposition of supersaturated  $\alpha_{\text{Cu}}$  solution already started at  $T_{m1}$  by precipitation of fine 10 to 20 nm large metastable particles.

During heating over the second distinctive temperature  $T_{m2}$  complete precipitation of iron and nickel stable and metastable phosphides with higher Fe/P or Ni/P ratio had occurred. At even higher temperatures, redissolution of nickel back into  $\alpha_{\text{Cu}}$  solution takes place, by transformation of metastable to stable  $\text{Ni}_2\text{P}$  phosphides with lower Ni/P ratio.

## REFERENCES

- [1] P. G. Slade: Electrical Contacts, Principles and Applications, Marcel Dekker, New York, 1999.
- [2] M. Braunovic, N.K. Myshkin, V. Konchits: Electrical Contacts, Taylor & Francis, London, 2006.
- [3] D. Klobčar, J. Tušek, M. Bizjak, V. Lešer: Metallurgy, 53 (2014) 4, 509 – 512.
- [4] J.R. Davis, Copper and Copper Alloys, ASM International, Materials park, Ohio, 2001.
- [5] Y. Yanamoto, G. Sasaki., K. Yamakawa, M. Ota: Hitachi Cable Review No. 19, Tokio, 2000.
- [6] Y. Yamamoto, H. Takano, M. Ohta., C. Tong., A. Kunishige: Hitachi Cable Review No. 26, Tokio, 2007.
- [7] M. Bizjak, B. Kosec, IRT 3000, 6 (2011) 36, 32-33.
- [8] P. Pečin, M. Bizjak, M. Pribošek, M. Godec, S. Ribarič, J. Rozman, Materials and Technology, 47 (2013) 6, 837-843.
- [9] B. Zorc, L. Kosec: Revista de Metallurgia, 36 (2000) 2, 100 – 107.
- [10] B. Zorc, L. Kosec: Metall, 58 (2004) 5, 290 – 294.
- [11] D. Klobčar, L. Kosec, B. Kosec, J. Tušek: Engineering Failure Analysis, 20 (2012) 1, 43-53.
- [12] H. Cao, J.Y. Min, S.D. Wu, A.P. Xian, J.K. Shang: Material Science and Engineering, A 431 (2006), 86-91.
- [13] ASM Handbook Volume 3: Alloy Phase Diagrams, Materials Park, Ohio, 1992.
- [14] J.H. Choi: Material Science and Engineering, A 550 (2012), 183-190.
- [15] J.H. Choi, D.N. Lee: Materials Science and Engineering A, 458 (2007), 295-302.
- [16] G. Kosec, A. Nagode, I. Budak, A. Antic, B. Kosec: Engineering Failure Analysis, 18 (2011) 1, 450-454.
- [17] J.S. Byun, J.S. J.H. Choi, D.N. Lee: Scripta Materialia, 45 (2000), 637-643.
- [18] P.D. Lu, J. Wang, W.J. Zeng, Y. Liu, L. Lu, B.D. Sun: Materials Science and Engineering A, 421 (2006), 254-259.

**Note:** The responsible translator for English language is Urška Letonja Grgeta, MOAR, Podgora, Slovenia.